

DR. KAISER

precision through diamond

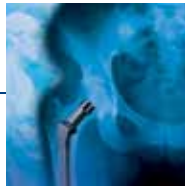

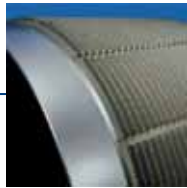

APPLICATION AREAS



TOOL
TECHNOLOGY FOR

4

COMPANY HISTORY

6

AUTOMOBILES

GEAR SHAFTS · BEVEL GEARS · SPUR GEARS
INJECTION SYSTEMS · VALVES · CAM AND
CRANK SHAFTS · PISTONS · BALL HUBS

7

ENERGY

DRIVE SHAFTS · BEARINGS · COG WHEELS
STEAM TURBINES · SOLAR TECHNOLOGY

8

AERONAUTICS

TURBINE BLADES · WEAR PROTECTION
HYDRAULIC AND CONTROL SYSTEMS · TURBO PUMPS

9

MEDICINE

IMPLANTS · DENTAL TECHNOLOGY · PROSTHESES
BALL AND SOCKET JOINTS · LABORATORY AND REHAB
TECHNOLOGY

10

MACHINE TOOLS

FLAT, PROFILE, THREADED, CENTRELESS,
GEAR, INTERNAL/EXTERNAL CYLINDRICAL AND
TOOL GRINDING MACHINES

11

OUR FIELDS OF ACTIVITY

PRECISION THROUGH DIAMOND

From a small enterprise, run from home, to a modern company with a worldwide reputation.

Dr. Michael Kaiser started his "shop for diamond tools" over thirty years ago as a small enterprise run from home. The company has grown to a modern company with a world-wide reputation, constantly expanding product lines through the creation of flexible and powerful production units. The company's goal has always been to be a problem-solver for all customers' questions, "regarding the grinding zone". The company's success comes from providing the highest precision products by consulting with individual customers to produce the best possible performance for its tools. The company, founded in 1977, had its first office in a cellar while the production of its first product, stationary diamond dressing tools, was performed on simple, small machines in a garden shed with an area of 7,55 m². In 1979 the company relocated to its first manufacturing facility and started production of rotary diamond dressing tools. In 1986, the product line was expanded with the introduction of a production department to manufacture diamond wear protection components and point crush dressing tools for the profiling of vitrified bond diamond grinding wheels.

Over the years, the number of production departments has grown in order to focus our manufacturing capabilities on customer's production requirements. In order to maximize performance of our rotary diamond dressers, a production department for dressing spindles using speed control and acoustic sensing technology was established.

In 1989, the precision electroplating department started production of electroplated dressing wheels with special focus on the dressing of gear grinding wheels. Production departments for manufacture of special application tools, such as stationary dressing tools using manmade diamonds and rotary dressers for ceramic bond CBN grinding wheels were established as new products based on existing DR. KAISER product and manufacturing technology. This was done in order to build a focused customer oriented manufacturing organization. In 2004 the production department for hard machining applications using electroplated CBN and diamond grinding products was established.

The high precision reverse plated profile roller department, which provides high precision and geometrically complex dressing tools, was established as an independent department in 2007. In 2009, DR. KAISER established manufacturing and technical support capability for the production and application of Vitrified CBN and Diamond grinding wheels. DR. KAISER now has the ability to offer our customers a complete system solution for high performance super abrasive grinding wheels and rotary diamond dressing tools.

DR. KAISER is represented by a worldwide team of technical organizations providing product and process solutions to grinding and dressing operations.

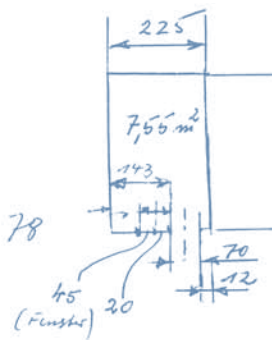

Layout of the first production site of Dr. Kaiser.

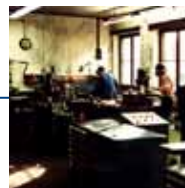

The beginnings of Dr. Kaiser from 1977, the corner stone for innovative precision tools.

QUALIFIED, MOTIVATED, CUSTOMER-ORIENTATED

The greatest resource and potential of DR. KAISER, alongside the modern machines and equipment, the over 280* highly-qualified, is its committed employees at the site in Celle. This is also complemented by a technically-orientated sales team and worldwide sales partners in all relevant markets.

* End of 2011



In addition to substantial further and continual education, the commitment and motivation of each individual is crucial in ensuring the quality of the products and competent application consulting.

Precision tools and services from DR. KAISER are based on the highest quality benchmarks. In 1999 we introduced a quality management system as per DIN EN ISO 9001 and are regularly re-certified as an exemplary company.

Here's to trustful cooperation!

The trend towards high-strength, hard to process materials in manufacturing is just as prevalent as the demand for reliable production sites which produce goods virtually around the clock. High-precision, demanding and innovative tools, as produced by DR. KAISER, are therefore a part of the future.

In order to make sure that our customers are able to rely on the highest level of product and service quality at all times, considerable investments are also directed into employee qualifications, research and development.



In the future our tools and problem solutions will also be orientated to the interests and requirements of our customers. Precision tools from DR. KAISER are developed and produced in accordance with their respective application. This guarantees that all sides profit from a trusting and successful cooperation.

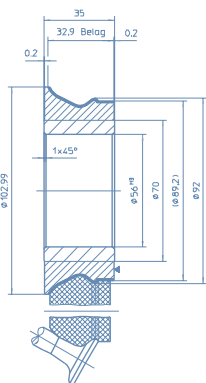
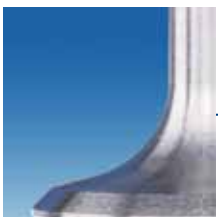
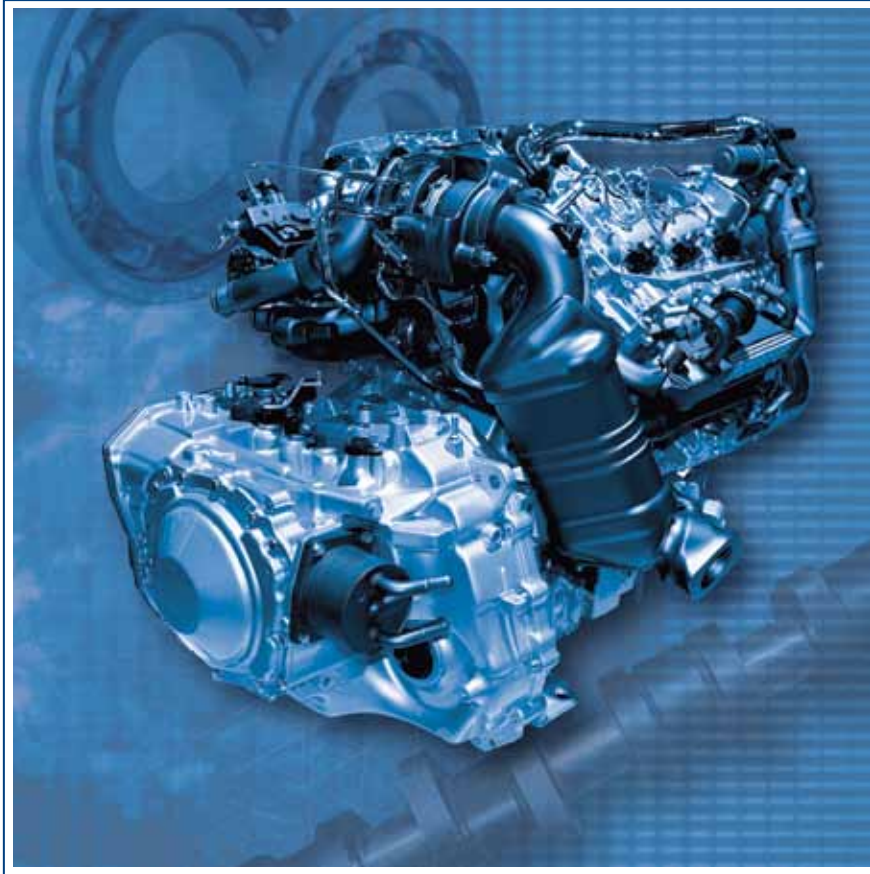

PROCESS RELIABILITY

... is a vital factor of success in the automobile industry. In the mass production of items such as crank shafts, cam shafts, valves, valve pins or drive components, powerful precision tools are irreplaceable. Here they must always meet the highest quality demands, continually contribute toward process

optimisation and be able to meet new innovative challenges. Dynamic, efficient processes conserve resources and reduce costs. Innovative, reliable precision tools and their constant optimisation thereby guarantee technological progress.

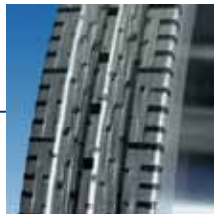

FLEXIBILITY

... is what drives efficient production. On the fast growing power generation market, quickly adaptable solutions guarantee the smooth functioning of this sophisticated technology. The power train of wind power plants for example is exposed to severe strains.

Gear boxes and rotating parts have to be optimally designed and produced with regards to size, weight and life span. Here, innovated grinding processes

with high erosion resistance make a significant contribution to the highest surface quality and form accuracy on the severely strained components. High-precision dressing tools are a fundamental requirement for optimising machining. Our customers appreciate the excellent cutting performance and high wear resistance. Day by day, process by process.

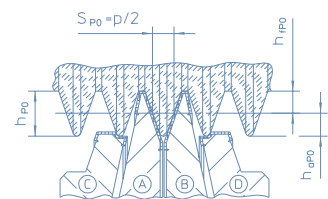

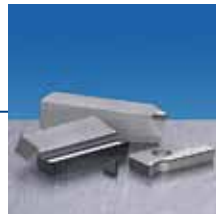

RELIABILITY

... is a criterion of vital importance in aeronautics and aerospace engineering. Here components and modules designed for security and performance are just as vital as energy saving turbines. The functionality of the individual systems has to be guaranteed in particular under the most demanding technical, economic and ecological conditions. The manufacturing processes for these

components have to be continuously optimised, in order to also be able to meet the most cost-efficient future production chains. Precision tools guarantee a high degree of precision, reproducibility and availability. As a development partner we give our clients and customers impulses to make their manufacturing even more effective and flexible.

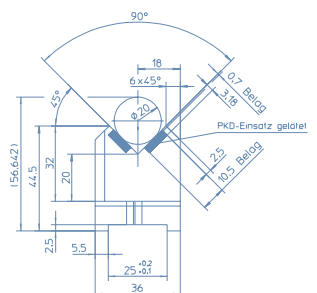

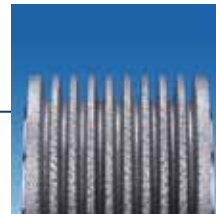
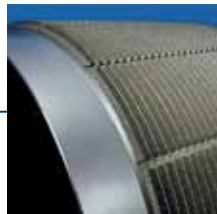

TRUST

... is a special challenge in medical engineering, above all if it is regarding the preservation and restoration of human health. Under consideration of individual requirements, innovations provide a large degree of quality of life to everyone. Complex solutions in this area have to combine medical requirements and optimal engineering output. In the development of medical-engineering components, the main attention is directed towards reliability

and compatibility.

In manufacturing technology, complex designs and high-strength, hard to process materials represent a special challenge. If you are able to rely on a competent partner, then you can enjoy vital competitive advantages. A partner who is a leader in the development of precision tools and also seems to be able to make the impossible happen.

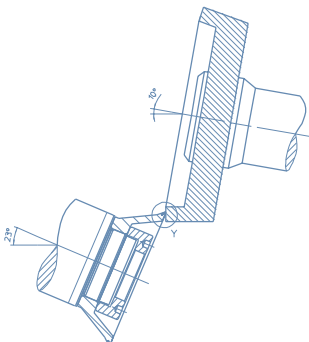

INNOVATIVE STRENGTH

... in the construction of tools and machinery is just as important as the demand for product quality. Only those who develop technical innovations today guarantee their success in the future. Machines with optimally functioning systems are the fundamental requirement for stability and growth. As a supplier we will meet the demand for constant process optimisation by the continuous development of new, well-engineered and efficient precision tools.

The realisation of new product generations and manufacturing processes does not just require wear-resistant guides and supports, but also optimal drive units for adaptable dressing tools and technologies. For this purpose DR. KAISER DIAMANTWERKZEUGE persistently continues to develop precision tools. The visions of today are the solutions of tomorrow.



EVERYTHING FROM
A SINGLE SOURCE:

DRESSING DISCS

SINGLE AXIS PLUNGE DRESSING ROLLERS

POINT CRUSH DRESSING DISCS

DRESSING SYSTEMS FOR VITRIFIED
CBN GRINDING WHEELS

ROTARY DRESSERS FOR
GEAR GRINDING

DRESSING SPINDLE SYSTEMS

ELECTROPLATED CBN- AND
DIAMOND GRINDING WHEELS

VITRIFIED BONDED CBN-
AND DIAMOND GRINDING WHEELS

PCD- AND CBN CUTTING TOOLS

PCD WEAR PROTECTION
COMPONENTS

STATIONARY DRESSING TOOLS

HOW TO FIND US

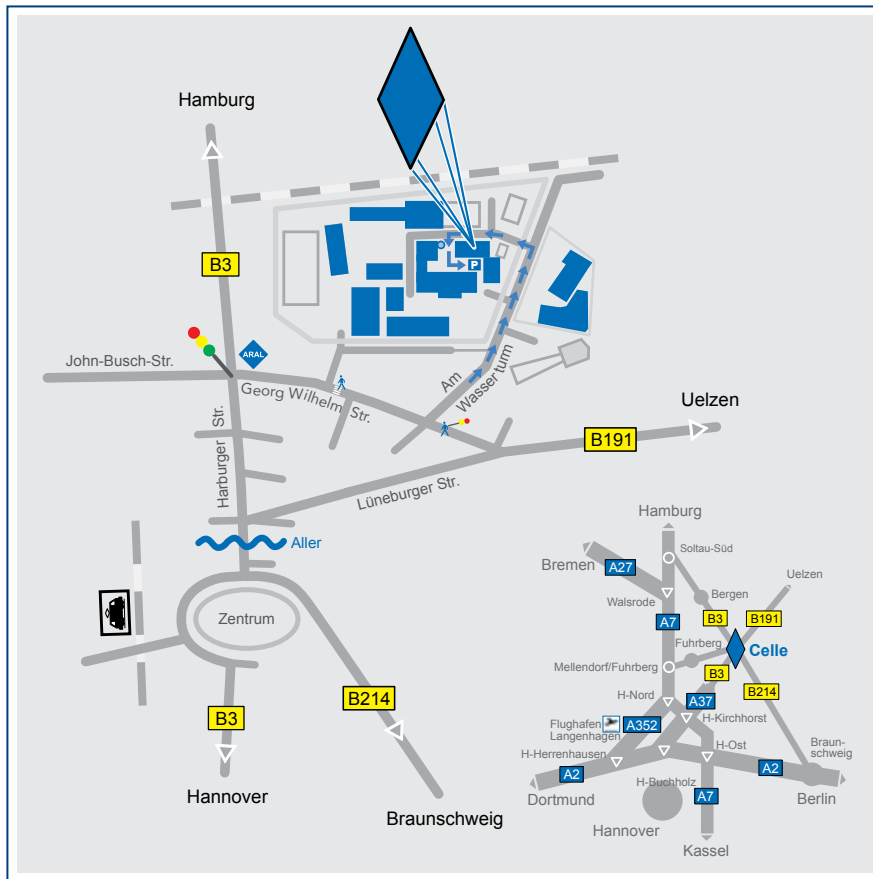

DR. KAISER
präzision durch diamant

DR. KAISER DIAMANTWERKZEUGE
GmbH & Co. KG

Am Wasserturm 33 G · 29223 Celle

Tel. +49 (0)5141 9386-0

Fax +49 (0)5141 9386-6

info@drkaiser.de · www.drkaiser.de